



aspire

DA VINCI QUATTRO

aspire for... Mobility Support Comfort

Electric Lift & Recline Chair Features

- 4 x motor lift chair for recline, legrest, lumbar and headrest movements
- Hand control with integrated USB charging port
- Chaise padding design fully supports legs, redistributing pressure
- Available in a large range of colours to suit modern home environments
- Integrated headrest support allowing safe and accurate head positioning
- Integrated lumbar support promotes posture and seating position



Gunmetal in main image

FABRIC SWATCHES



Latte



Gunmetal



Fog



Dove

CODE	DESCRIPTION	SEAT WIDTH	SEAT DEPTH	SEAT-TO-FLOOR	SWL
CHP227500	Aspire Da Vinci - Quattro - Latte	508 mm	520 mm	495 mm	159 kg
CHP227510	Aspire Da Vinci - Quattro - Gunmetal	508 mm	520 mm	495 mm	159 kg
CHP227520	Aspire Da Vinci - Quattro - Fog	508 mm	520 mm	495 mm	159 kg
CHP227530	Aspire Da Vinci - Quattro - Dove	508 mm	520 mm	495 mm	159 kg



movemobility.com.au



DA VINCI LIFT RECLINE CHAIR

USER MANUAL

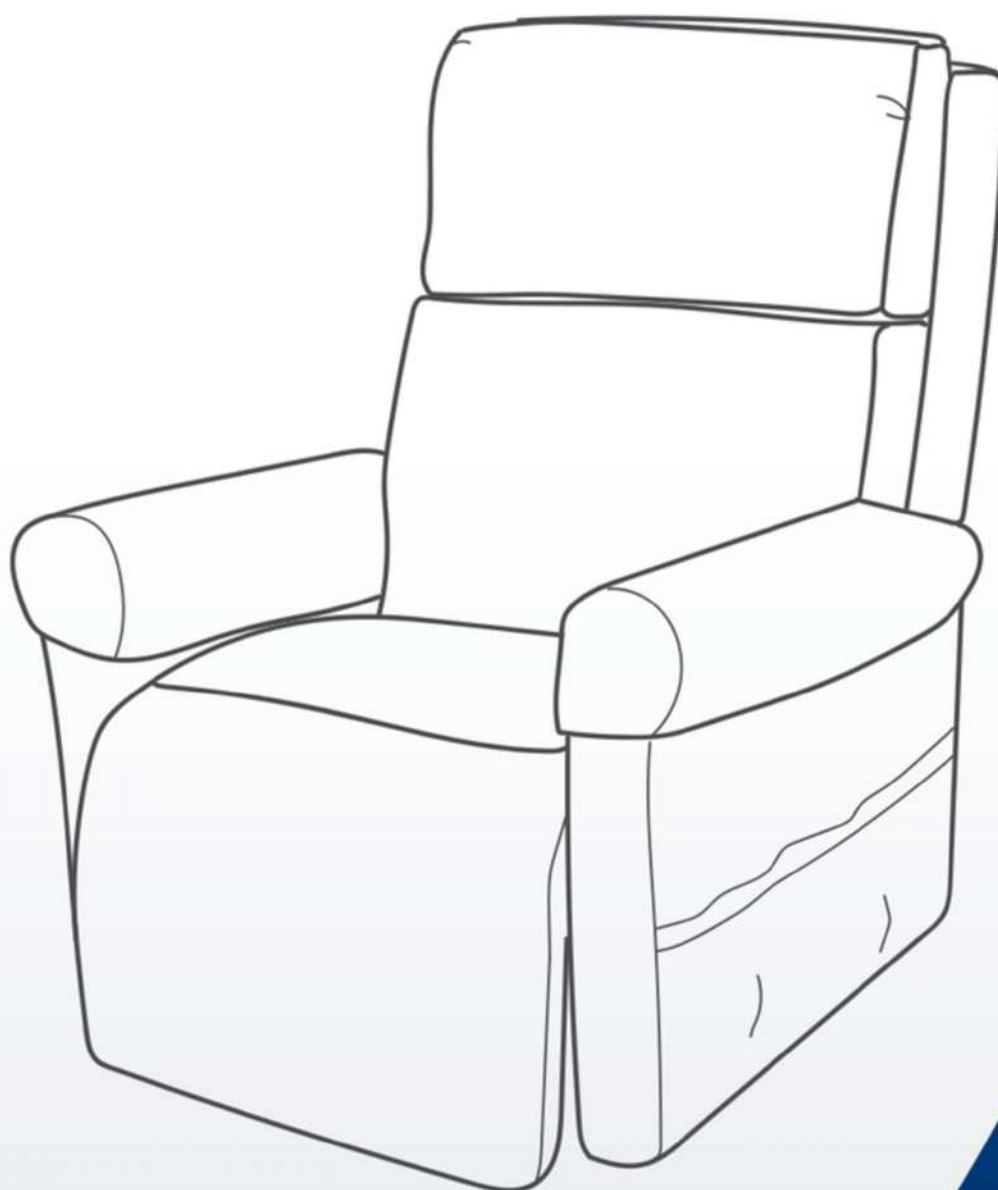

ASPIRE ELECTRIC LIFT & RECLINE CHAIRS

The symbols below are used throughout this owner's manual and on the product to identify warnings and important information. It is very important for you to read them and understand them completely.

 **WARNING!** Indicates a potentially hazardous condition/situation. Failure to follow designated procedures can cause either personal injury, component damage or malfunction. On the product, this icon is represented as a black symbol on a yellow triangle with a black border.

 **MANDATORY!** These actions should be performed as specified. Failure to perform mandatory actions can cause personal injury and/or equipment damage. On the product, this icon is represented as a white symbol on a blue dot with a white border.

 **PROHIBITED!** These actions are prohibited. These actions should not be performed at any time or in any circumstances. Performing a prohibited action can cause personal injury and/or equipment damage. On the product, this icon is represented as a black symbol with a red circle and red slash.

Please fill out the following information for quick reference:

















Aspire Dealer
Address
Phone Number
Purchase Date
Serial Number

NOTE: This owner's manual is compiled from the latest specifications and product information available at the time of publication. We reserve the right to make changes as they become necessary. Any changes to our products may cause slight variations between the illustrations and explanations in this manual and the product you have purchased. The latest/current version of this manual is available on our website.

LABEL INFORMATION

PRODUCT SAFETY SYMBOLS

The symbols below represent labels used on the product to identify warnings, mandatory actions and prohibited actions. It is very important for you to read and understand these symbols completely. Do not remove these labels from your product. Please note that not all of the symbols may be used on your lift chair model.

	Pinch/Crush Points Hazard! Do not place objects or appendages in the path of moving parts.		Do not place objects under the footrest when the lift chair is in the fully reclined position. Make sure area is clear of obstructions, including pets and small children during operation.
	Electrical Hazard		Do not cover or place the external transformer under the riser recliner. Keep in an open, well-ventilated area free from foreign material and away from possible pinch points.
	Read and follow the information in the owner's manual.		Battery Door Location
	Maximum weight capacity		Indoor Use Only. Avoid exposure to rain, snow, ice, salt or standing water. Maintain and store in a clean and dry environment.
	Do not connect an extension lead to the AC/DC converter or the battery charger.		Class II Equipment
	Removal of grounding prong can create electrical hazard. If necessary, properly install an approved 3-pronged adapter to an electrical outlet having 2-pronged plug access.		Green LED indicates power to the unit is on. Not applicable to all models.
	Properly dispose of all electronic components, including the external transformer, hand control, batteries, actuator motors and wiring. Contact your authorised Aspire Dealer for more information.		Degree of protection against electric shock.
	Do not place objects under the lift chair. Make sure the area is clear of obstructions, including pets and small children during operation.		This product has been tested and complies to IEC 60601-1-2.

1. INTRODUCTION

TABLE OF CONTENTS

1. Introduction	5
2. General Guidelines	6
3. Important Safety Instructions	8
4. Warranty	9
5. Assembly/Disassembly	10
• Cord and Transformer Connections	
• Chair Assembly	
• Operating Your Lift Chair	
• Installation of Back-up Batteries	
• Troubleshooting	
6. Care & Maintenance	14
7. Specifications	15

SAFETY

CONGRATULATIONS on purchasing your Aspire Lift Chair. The product you have purchased combines state-of-the-art components with **safety**, comfort and styling in mind. We are confident the design features will provide you with the conveniences you expect during your daily activities. Understanding how to **safely** operate and care for this product should bring you years of trouble-free operation and service.

Read and follow all instructions, warnings and notes in this manual and all other accompanying literature before attempting to operate this product for the first time. In addition, your **safety** depends upon you, as well as your dealer, carer or healthcare professional in using good judgement.

If there is any information in this manual which you do not understand, or if you require additional assistance for setup or operation, please contact your authorised Aspire Dealer. **Failure to follow the instructions, warnings and notes in this manual and those located on your Aspire product can result in personal injury or product damage and will void the Aspire product warranty.**

PURCHASER'S AGREEMENT

By accepting delivery of this product, you promise that you will not change, alter or modify this product or remove or render inoperable or unsafe any guards, shields or other safety features of this product; fail, refuse or neglect to install any retrofit kits from time to time provided by Aspire to enhance or preserve the safe use of this product.

INFORMATION EXCHANGE

We want to hear your questions, comments and suggestions about this manual. We would also like to hear about the safety and reliability of your new lift chair and about the service you received from your authorised Aspire Dealer. Please notify us of any change of address, so we can keep you apprised of important information about safety, new products and new options that can increase your ability to use and enjoy your lift chair.

Please feel free to contact us at the address below:

Australia:

Aidacare Head Office
Building 3A, 1 Moorebank Avenue,
Moorebank NSW 2170

NOTE: If you ever lose or misplace your product registration card or your copy of this manual, contact us and we will be glad to send you a new one immediately.

NOTE: When placing the furniture on non-carpeted flooring, Aspire recommend the use of floor protection such as an area rug or furniture pads. Area rugs and padding not included with purchase.

NOTE: This device complies with part 15 of the FCC rules. Operation is subject to the following two conditions: (1) this device may not cause interference, and (2) this device must accept any interference, including interference that may cause undesired operation of the device. Modifications not approved by the party responsible for compliance could void user's authority to operate the equipment.

2. GENERAL GUIDELINES

Your lift chair is a state-of-the-art life-enhancement device designed to increase mobility. Please be aware that the final selection and purchasing decision regarding the type of lift chair to be used is the responsibility of you, the lift chair user, if capable of making such a decision, and/or your healthcare professional (i.e., medical doctor, allied health professional, therapist, etc.).



MANDATORY: Read and follow the information provided in this owner's manual before attempting to operate your lift chair for the first time.

There are certain situations, including some medical conditions, where you will need to practice operating the lift chair in the presence of a trained attendant. A trained attendant can be defined as a family member or healthcare professional specially trained in assisting you with performing various daily living activities while safely operating a lift chair.

Below are some precautions, tips and other safety considerations that will help you become accustomed to operating the lift chair in a safe manner.

MODIFICATIONS

Aspire chairs are designed and engineered to provide maximum comfort and utility. However, to prevent personal injury and/or damage to your lift chair, you should not modify, add, remove or disable any feature, part or function of your lift chair. Unauthorised modifications may also void your product's warranty.

NOTE: Use Aspire approved parts only for all repairs and replacements.

WEIGHT LIMITATIONS

Your lift chair is rated for a maximum weight capacity. Refer to "Appendix A" for more information.



MANDATORY: Stay within the specified weight capacity of your lift chair. Failure to do so may result in injuries and/or product damage, Aidacare will not be held responsible for any such issues/failures.

PINCH/CRUSH HAZARDS

The scissor and lift mechanisms are labelled as pinch/crush point hazards on your lift chair. Keep clear of these areas and make sure the path of motion is unobstructed.



WARNING! Do not place objects or appendages in the path of moving parts.

DEGREE OF PROTECTION/MODE OF OPERATION

- Class II equipment/Type B protection against electric shock
- Degree of protection against the ingress of solid/liquids—IPX0

ELECTROMAGNETIC AND RADIO FREQUENCY INTERFERENCE (EMI/RFI)



WARNING! Laboratory tests have shown that electromagnetic and radio frequency waves can have an adverse affect on the performance of electrically-powered devices, such as lift chairs.

Electromagnetic and Radio Frequency Interference can come from sources such as cellular phones, mobile two-way radios (such as walkie-talkies), radio stations, TV stations, amateur radio (HAM) transmitters, wireless computer links, Wifi, microwave signals, paging transmitters and medium-range mobile transceivers used by emergency vehicles. In some cases, these waves can cause unintended movement or damage to the control system of electrically-powered devices. The lift chair user can help prevent electromagnetic interference by maintaining a minimum distance between portable and mobile RF communications equipment. It is recommended that at least 3 metres (9 feet) of distance be maintained between the lift chair and any handheld equipment emitting 10 W or more of output power. Refer to the manufacturer's literature for the handheld device to determine the maximum output power of that device.

Every electrically-powered device has an immunity (or resistance) to EMI. The higher the immunity level, the greater the protection against EMI. Per EMC standards, this product has passed immunity testing and is rated as a Group 1, Class B product, meaning the lift chair uses RF energy only for its internal function. Therefore, its RF emissions are very low and are not likely to cause any interference in nearby electronic equipment making the lift chair suitable for use in all establishments, including domestic establishments and hospitals.



WARNING! Be aware that cell phones, two-way radios, laptops and other types of radio transmitters may cause unintended movement of your electrically-powered device due to EMI. Exercise caution when using any of these items while operating your lift chair.



WARNING! The addition of accessories or components to the lift chair can increase the susceptibility of the chair to EMI. Do not modify your lift chair in any way not authorised by Pride.

WARNING! Your lift chair itself can disturb the performance of other electrical devices located nearby, such as alarm systems.

NOTE: If unintended motion occurs, discontinue use of the lift chair. Contact Aidacare to report the incident.

SHIPPING AND DELIVERY

Before using your lift chair, make sure your delivery is complete as some components may be packaged individually. If you do not receive a complete delivery, please contact your authorised Aspire Dealer immediately. Where damage has occurred during transport, either to the packaging or content, please contact the delivery company responsible.

MOTOR VEHICLE TRANSPORT

If you will be transporting your lift chair in a motor vehicle, individual components (external transformer, etc.) should be secured. The lift chair itself must also be secured (a possible hazard during vehicle braking).

3. IMPORTANT SAFETY INSTRUCTIONS

READ ALL INSTRUCTIONS BEFORE USING.

WARNING: To reduce the risk of burns, fire, electric shock, or injury to persons:

- **DANGER:** To reduce the risk of electric shock, always unplug this furnishing from the electrical outlet before cleaning
- Unplug from outlet before putting on or taking off parts
- Close supervision is necessary when used by (or near) children and disabled people
- Use this furnishing only for its intended use (as described in these instructions). Do not use attachments not recommended by the manufacturer
- Never operate this furnishing if it has a damaged cord or plug, if it is not working properly, if it has been dropped/damaged, or dropped into water
- Keep the cord away from heated surfaces
- Never drop or insert any object into any opening
- Do not use outdoors. Just for household, indoor use only
- Do not operate where aerosol (spray) products are being used, or where oxygen is being administered
- To disconnect, turn all controls to the off position, then remove plug from outlet
- **WARNING:** Risk of injury - keep children away from extended legrest
- **WARNING:** Risk of injury to persons - do not use this furnishing to support video equipment, such as televisions or computer monitors
- When not in use, it is recommended the hand control be stored securely in the pocket on the outside of the arm

SAVE THESE INSTRUCTIONS

SERVICING OF DOUBLE-INSULATED PRODUCTS:

In a double-insulated product, two systems of insulation are provided instead of grounding. No grounding means is provided on a double-insulated product, nor is a means for grounding to be added to the product. Servicing a double-insulated product requires extreme care and knowledge of the system, and is to be done only by qualified service personnel. Replacement parts for a double-insulated product must be identical to the parts they replace.

4. WARRANTY

FIVE-YEAR LIMITED WARRANTY

For five (5) years from the date of purchase, Aspire will repair or replace at our option to the original purchaser any of the following parts found upon examination by an authorised representative of Aspire to be defective in material and/or workmanship:

- Steel Frame
- Motor
- Scissor Mechanisms
- Steel Lift Mechanism

NOTE: Aspire reserves the right to replace only the part of the steel lift mechanism that may be defective. Aspire provides parts only under warranty. Your Aspire Dealer is responsible for labour and service. Please contact your Aspire Dealer for information about these services and for any applicable charges.

TWO-YEAR FABRIC WARRANTY

Aspire guarantees to replace any fabric that is found to be faulty as a result of manufacturing defect and which has been used in accordance with our manufacturer performance ratings and care instructions. An evaluation of fabric related issues must be conducted before confirmation of warranty coverage can be verified. Aspire recommends stain resistant treatment before use.

WARRANTY DURATION

Frame: 5 Years

Mechanisms: 5 Years

Electronics: 2 Years

Handset and Cable: 2 Years

Fabric: 2 Years

CONSUMER WARRANTY AGAINST DEFECTS:

Aspire does not warrant against excessive or incorrect use, modification or any situation that could not be deemed as fair wear and tear. This is a back to base warranty and does not cover freight costs pertaining to the return of any items under warranty. Aspire acknowledges and conforms to all ACCC guidelines around consumer rights.

Aspire will not warrant the safety and or correct functioning of products where any original components have been changed or modified by non-Aspire approved and trained service and maintenance staff or external providers. Furthermore, safety is not guaranteed where components have been replaced with non-original Aspire approved parts. If any faults are detected upon receipt of this product please contact Aspire. Any faults that are detected during normal use should be reported to Aspire immediately to determine if warranty conditions apply and if so, the necessary repair or replacement work to be completed.

5. ASSEMBLY/DISASSEMBLY

CORD AND TRANSFORMER CONNECTIONS

Once the box has been removed from around the chair, you'll notice the back is resting on top of the seat. There are a couple of items to remove from the seat portion of the chair first.

Follow the steps below:

1. Remove the zip tie holding the plastic bag with the Power Transformer, hand control and its cord on the left
2. Remove the hand control from the plastic bag and connect it to the female plug located in the left side pocket on the outside of the chair's arm
3. Connect the Power Transformer to the plug coming from the chair
4. Connect the Power Cord into the Power Transformer
5. Connect the Power Cord into an electrical outlet, near where the chair will be positioned

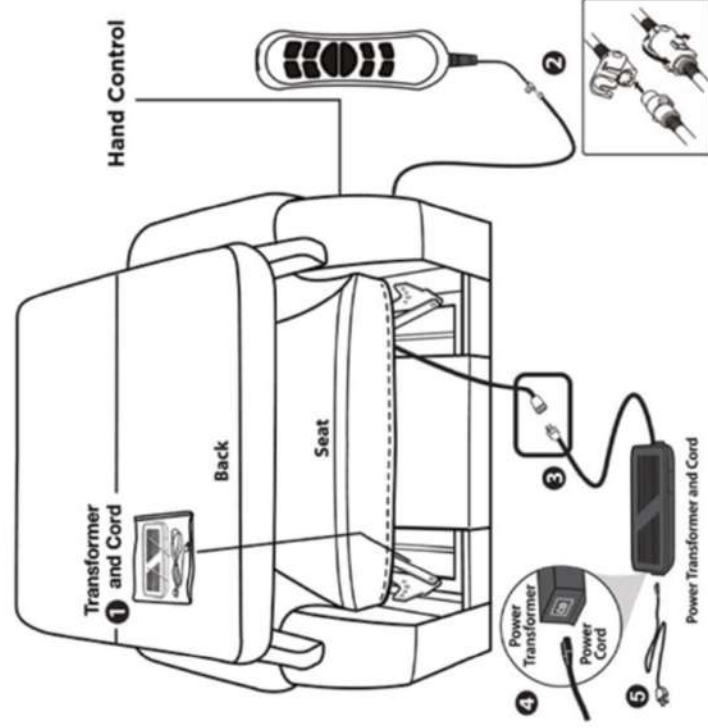

CHAIR ASSEMBLY: ATTACHING THE CHAIR BACK TO THE CHAIR BASE

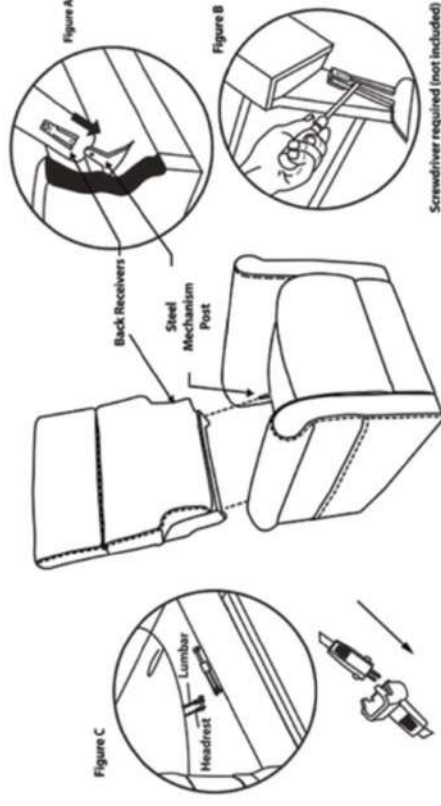

CAUTION: PLEASE READ ALL INSTRUCTIONS CAREFULLY BEFORE STARTING ASSEMBLY PROCESS. IT IS RECOMMENDED TO USE TWO PEOPLE WHEN ASSEMBLING AND REMOVING THE INSIDE BACKS TO AND FROM THE BASE OF THE FURNITURE.

1. Slide inside back receivers onto the steel mechanism posts in the base of the chair (Figure A)
2. Press both sides of the back firmly into place until the back automatically locks into place
3. To remove the back from the base, use a screwdriver pressing outward on the black tab in the metal receivers on both sides of the chair back and lift the back from the base of the chair (Figure B)
4. Connect the Headrest and Lumbar cable plugs (Figure C). Headrest-only models feature one less set of cables

CHAIR ASSEMBLY: ATTACHING THE CHAIR WINGS TO THE CHAIRBACK

1. Slide the metal inserts on the chair's wings into the metal sleeves on the side of the chair back
2. Slide the wings down until they are completely set on the back's metal sleeves

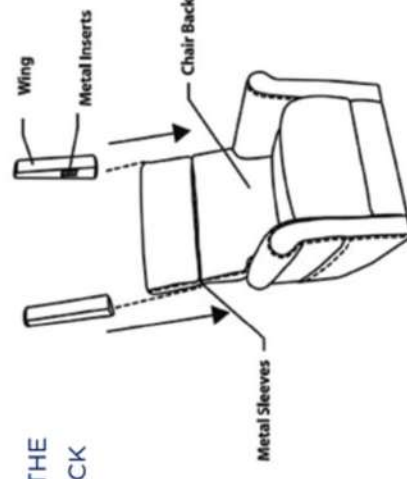

OPERATING YOUR LIFT CHAIR

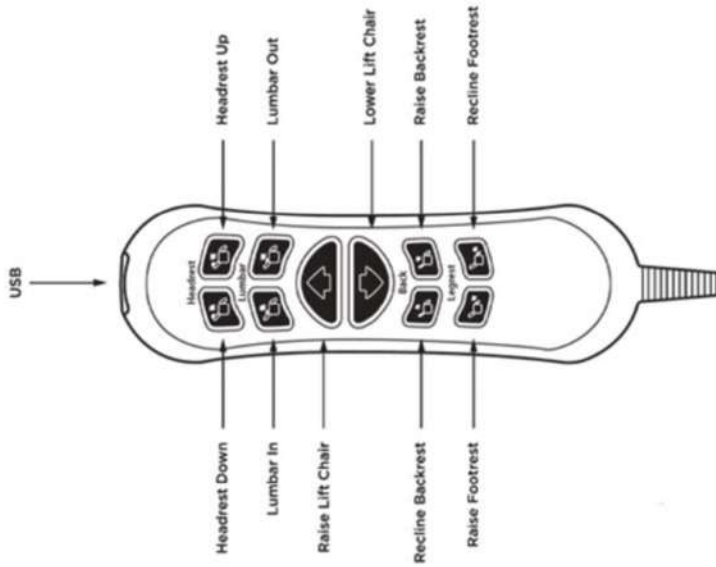

INSTALLATION OF BACK-UP BATTERIES

If your chair is equipped with an external transformer with a lithium-ion battery pack, your chair may be operated without being plugged into an electrical outlet for up to 48 hours.

Follow these steps to replace the lithium-ion battery pack batteries:

1. Unplug the external transformer power cord from the electrical outlet.
2. Position the external transformer so that the lithium-ion batter is facing upward.
3. Gently bump with your hand the end of the lithium-ion battery pack to dislodge it from the external transformer.
4. Slide the lithium-ion battery until it stops and then lift the lithium-ion battery off of the external transformer.

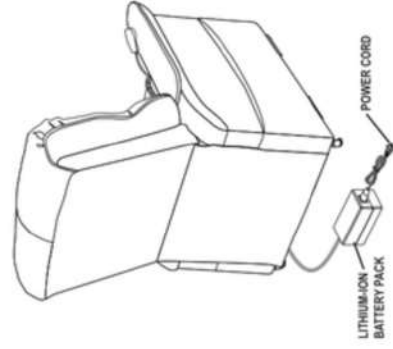

Figure A Lift Chair Battery Back Up Location

5. Place the new lithium-ion battery on top of the external transformer with the securement grooves toward the external transformer. (Figure B)
6. Slide the new lithium-ion battery onto the external transformer until it clicks into place.

NOTE: Remove the lithium-ion battery from the battery pack when your chair isn't being used for an extended period of time. The chair will draw power from the battery even when it is not in use.

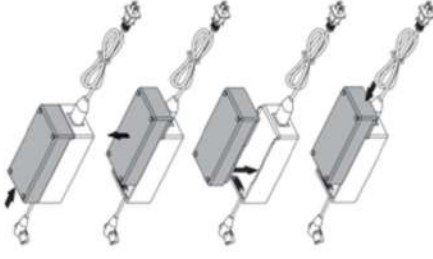

Figure B Lithium-ion Battery Replacement

TROUBLESHOOTING

PROBLEM	POSSIBLE FACTORS	SOLUTIONS
The chair doesn't recline or lift	The transformer may not be connected	Check the power supply has been correctly connected to the socket and confirm the wire from chair to transformer is firmly connected
The headrest or lumbar doesn't work	The headrest or lumbar motor may not be connected	Check the headrest and lumbar motor has been correctly connected to the socket
The headrest and lumbar work oppositely	The headrest and lumbar motor plug	Check the headrest and lumbar motor has been correctly connected to the socket
The hand control doesn't work	The hand control may not be connected	Check the hand control cord has been correctly connected to the socket

6. CARE AND MAINTENANCE

Your Aspire Lift Chair will require routine maintenance checks. You can perform some of these checks, but others may require assistance from an authorised Aspire Dealer. By following the maintenance checks in this section as scheduled, you can help ensure your lift chair gives you years of trouble-free operation. If you have any questions regarding your lift chair's care, contact your authorised Aspire Dealer.

FABRIC CARE

- Inspect the fabric on a regular basis for any pulls, tears or gaps
- Fabric care instructions can be found on the tag under the headrest cushion

WARNING! Fabric should not be allowed to come in direct contact with any type of heat source (e.g., a space heater or cigarette). Personal injury or fire damage may occur.

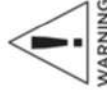

WARNING

WARNING! It is strongly recommended that you do not smoke cigarettes while seated in or using your lift chair, although the lift chair has passed the necessary testing requirements for cigarette smoking. You must adhere to the following safety guidelines if you decide to smoke cigarettes while seated in or using your lift chair.

- Do not leave lit cigarettes unattended
- Keep ashtrays a safe distance from the lift chair
- Always make sure cigarettes are completely extinguished before disposal

NOTE: Do not use solvent-type cleaners to spot clean. Do not saturate the fabric. Prevent damage to the fabric; do not expose the lift chair to direct sunlight.

ELECTRONICS CARE

- Inspect all wiring harnesses to make sure they are not damaged or frayed
- If damage is present, unplug the lift chair and contact your authorised Aspire Dealer for service
- Keep all electronics free from moisture and temperature extremes
- Aspire Lift Chairs are intended for indoor use only!

WARNING! Even though the lift chair has passed the necessary testing requirements for ingress of liquids, you should keep electrical connections away from sources of dampness, including direct exposure to water or bodily fluids and incontinence. Check electrical components frequently for signs of corrosion and replace as necessary.



WARNING

WARNING! Plastic bags are a suffocation hazard. Dispose of plastic bags properly and do not allow children to play with them.

7. SPECIFICATIONS

	SEAT HEIGHT	SEAT DEPTH	SEAT WIDTH	SEAT TO TOP OF BACK	OVERALL HEIGHT	OVERALL DEPTH	OVERALL WIDTH	DISTANCE FROM WALL	S.W.L.
CHP227500 Aspire Da Vinci Recliner (Latte)	480 mm	510 mm	530 mm	630 mm	950 mm	1055 mm	810 mm	650 mm	159kg
CHP227510 Aspire Da Vinci Recliner (Gunmetal)	480 mm	510 mm	530 mm	630 mm	950 mm	1055 mm	810 mm	650 mm	159kg
CHP227520 Aspire Da Vinci Recliner (Fog)	480 mm	510 mm	530 mm	630 mm	950 mm	1055 mm	810 mm	650 mm	159kg
CHP227530 Aspire Da Vinci Recliner (Dove)	480 mm	510 mm	530 mm	630 mm	950 mm	1055 mm	810 mm	650 mm	159kg



MANDATORY! Stay within the specified weight capacity of your lift chair. Exceeding the weight capacity voids Aspire Lift Chair warranty.



MOBILITY

movemobility.com.au